

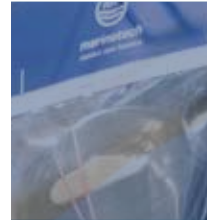

marinotech
stainless steel fasteners



new



2

0

2

5

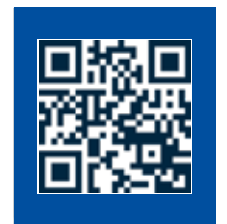
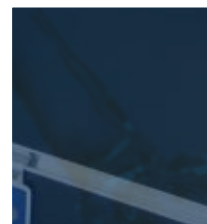
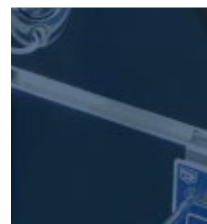
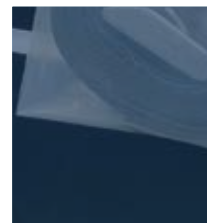
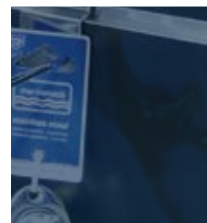
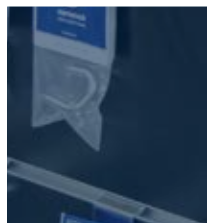
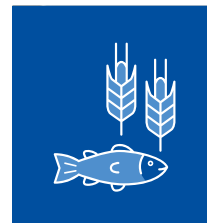
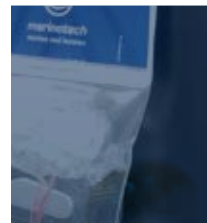



Für das gesamte Sortiment gilt:

- Empfohlene Verkaufspreise ohne MwSt auf Anfrage
- Alle Maß- und Belastungsangaben sowie Abbildungen sind unverbindlich
- Grundsätzlich sind alle Artikel nicht für das Heben von Lasten bzw. für die persönliche Schutzausrüstung (PSA) vorgesehen
Die Artikel, die für das Heben von Lasten vorgesehen sind, sind speziell gekennzeichnet 
- Mögliche technische Änderungen behalten wir uns vor
- Alle Bruchlast- und / oder Arbeitslastangaben sind nur gültig bei korrekter axialer 1-Strang-Aufhängung ohne Aufspreizung



The following applies to the entire range:

- Suggested retail price without tax on demand
- All dimensional and loading information as well as to illustrations are non-binding
- As a basic principle, all articles are not intended for lifting loads or for use as personal protective gear
Articles which are intended for lifting loads are specially labelled 
- We reserve the right to make possible technical changes
- All breaking load and/or working load specifications are only valid for correct axial single-line suspension without spreading



Les points suivants s'appliquent pour l'ensemble de la gamme:

- Prix de vente recommandés hors taxes sur demande
- Toutes les dimensions et charge admissible ainsi que les illustrations sont non contractuelles
- De manière générale, l'ensemble des articles ne sont pas conçus pour soulever des charges ou pour l'équipement de protection personnel
Les articles conçus pour soulever des charges sont marqués en conséquence 
- Sous réserve d'éventuelles modifications techniques
- Toutes les spécifications concernant les charge de rupture et charge maximale d'utilisation sont valides à condition que le levage soit réalisé avec une seul élément, axial et centré

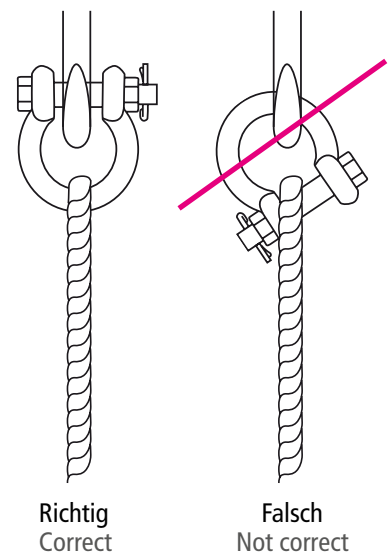

MT-Serie
MT series
Série MT



Duplex D6
Duplex D6
Duplex D6

Inhaltsübersicht | Index | Table des matières

8488 P. 6	8253 P. 6	8838 P. 6	8482 P. 6	8306 P. 7	815250 P. 7 NEW
815251 P. 7 NEW	8252 P. 7	8288 P. 8	8262 P. 8	8289 P. 8	8283 P. 9
8278 P. 9	815188 P. 9 NEW	815228 P. 10 NEW	8246 P. 10	8279 P. 10	8418 P. 10
8358 P. 11	8386 P. 11	8432 P. 11	815219 P. 11 NEW	8515 P. 12	815223 P. 12 NEW
815275 P. 12 NEW	815224 P. 13 NEW	815252 P. 13 NEW	815264 P. 13 NEW	815271 P. 13 NEW	8478 P. 14
815218 P. 14 NEW	815226 P. 14 NEW	815270 P. 14 NEW	815229 P. 15 NEW	8300 P. 15	8301 P. 15
815113 P. 15	815260 P. 16 NEW	815051 P. 16 NEW	815181 P. 16	8384 P. 16	815227 P. 17 NEW
8274 P. 17	815230 P. 17 NEW	815200 P. 17 NEW	815201 P. 18 NEW	815202 P. 18 NEW	815221 P. 18 NEW

Inhaltsübersicht | Index | Table des matières

8271 P. 18	815268 P. 19 NEW	814858 P. 19	8604 P. 19	815220 P. 20 NEW	814272 P. 20 NEW
815222 P. 20 NEW	8437 P. 21	815269 P. 21 NEW	815272 P. 21 NEW	8229 P. 22	8246 P. 22
8247 P. 22	8248 P. 23	8249 P. 23	8379 P. 23	8253 P. 24	8258 P. 24
8260 P. 24	8268 P. 25	8272 P. 25	8680 P. 25	815095 P. 26	816000 P. 26
815099 P. 26	816002 P. 27	815079 P. 27	815080 P. 27	815081 P. 28	814738 P. 28
814740 P. 28	815050 P. 29	814719 P. 29	814720 P. 29	DIN 125 P. 30	DIN 9021 P. 30
DIN 9054 P. 30	ISO 14581 P. 31	DIN 933 P. 31	DIN 934 P. 31	DIN 6923 P. 32	DIN 1587 P. 32
Art. 9047 P. 32	DIN 7981 P. 33	DIN 7982 P. 33	8152171140 P. 36 NEW	8152171141 P. 36 NEW	8152172034 P. 36 NEW
					

Inhaltsübersicht | Index | Table des matières

8152174010 P. 36 NEW 	8152174011 P. 36 NEW 	8152174020 P. 36 NEW 	8152174021 P. 37 NEW 	8152174030 P. 37 NEW 	8152174031 P. 37 NEW 
8152174032 P. 37 NEW 	8152174033 P. 37 NEW 	8152174040 P. 37 NEW 	8152174110 P. 38 NEW 	8152174110CBK P. 38 NEW 	8152174120 P. 38 NEW 
8152174120CBK P. 38 NEW 	8152174121 P. 38 NEW 	8152174121CBK P. 38 NEW 	8152174130 P. 39 NEW 	8152174131 P. 39 NEW 	8152174132 P. 39 NEW 
8152174132CBK P. 39 NEW 	8152174133 P. 39 NEW 	8152174133CBK P. 39 NEW 	8152174134 P. 40 NEW 	8152174135 P. 40 NEW 	8152174136 P. 40 NEW 
8152174150 P. 40 NEW 	8152174150CBK P. 40 NEW 	8152174151 P. 40 NEW 	8152174151CBK P. 41 NEW 	8152174152 P. 41 NEW 	8152174153 P. 41 NEW 
8152174154CBK P. 41 NEW 	8152174155CBK P. 41 NEW 	8152174160 P. 41 NEW 	8152174170 P. 42 NEW 	8152174171 P. 42 NEW 	

8488

Alu-Karabinerhaken / ALU

Alu spring hook / Mousqueton pompier en alu

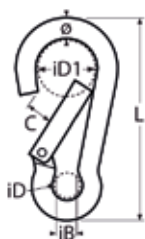

Artikel-Nr. Item-no.	Farbe Colour	ø	L	iD	iD1	C	iB	Box
NEW 848804 40	Gemischt / Mixed	4	40	6	11	7	3	10
NEW 848804 40BL	Blau / Blue	4	40	6	11	7	3	10
NEW 848804 40RO	Rot / Red	4	40	6	11	7	3	10
NEW 848804 40SI	Silber / Silver	4	40	6	11	7	3	10
NEW 848804 40GE	Gelb / Yellow	4	40	6	11	7	3	10
NEW 848804 40SC	Schwarz / Black	4	40	6	11	7	3	10

Weitere Größen finden Sie im Katalog auf Seite 70 oder unter marinetch.shop

Further sizes can be found in the catalog on page 70 or at marinetch.shop

Vous trouverez d'autres tailles dans le catalogue à la page 70 ou sur marinetch.shop

8253

Schraubverbinder / A4-AISI 316

Quick link / Maillon à visser



Artikel-Nr. Item-no.	ø	iL	iB	C	Antrieb Drive	**BLkg	Box
NEW 8253407	7	51	16,5	8,5	SW12	1800	10

Weitere Größen finden Sie im Katalog auf Seite 74 oder unter marinetch.shop

Further sizes can be found in the catalog on page 74 or at marinetch.shop

Vous trouverez d'autres tailles dans le catalogue à la page 74 ou sur marinetch.shop

8838

Schraubverbinder, lang / A4-AISI 316

Quick link, long / Maillon à visser, longue

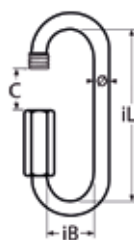

Artikel-Nr. Item-no.	ø	iL	iB	C	Antrieb Drive	**BLkg	Box
NEW 8838407	7	65	17,5	16,0	SW12	1800	10
NEW 8838416	16	129	29,5	29,5	SW26	8000	10

Weitere Größen finden Sie im Katalog auf Seite 74 oder unter marinetch.shop

Further sizes can be found in the catalog on page 74 or at marinetch.shop

Vous trouverez d'autres tailles dans le catalogue à la page 74 ou sur marinetch.shop

8482

Rundschäkel mit Innensechskant / A4-AISI 316

D-shackle with hexagon socket / Manille droite avec vis six pans creux

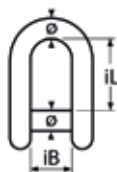

Artikel-Nr. Item-no.	ø	iL	iB	Antrieb Drive	**BLkg	Box
NEW 8482404	4	14	8	SW2,5	700	10

Weitere Größen finden Sie im Katalog auf Seite 85 oder unter marinetch.shop

Further sizes can be found in the catalog on page 85 or at marinetch.shop

Vous trouverez d'autres tailles dans le catalogue à la page 85 ou sur marinetch.shop

Schäkelschlüssel / A4-AISI 316
Multi-purpose shackle key / Démanilleur

8306

Artikel-Nr. Item-no.	L	iL	iD	Antrieb Drive	Antrieb 1 Drive 1	Antrieb 2 Drive 2	Box
83062100L	100	31	5	SW13	SW10	SW8	5

NEW

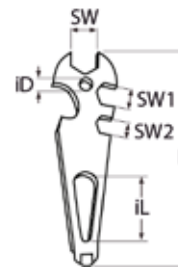

Herzschäkel, 3-Wege-Kettenschäkel, MT-Serie / A2-AISI 304
Heart shaped 3-way shackle, MT-series / Manille 3 voies en forme de cœur, MT-série

815250

Artikel-Nr. Item-no.	ø	L	B	iB	Antrieb Drive	Antrieb Drive	Box
815250206	6	30	30	8	TX20 Pin	SW10	10

NEW

Die passenden Bits Art. 815000 im Katalog auf Seite 417 oder unter marinetechnic.shop.
The matching bits Art. 815000 can be found in the catalog on page 417 or at marinetechnic.shop
Les embouts adaptés Art. 815000 dans le catalogue à la page 417 ou sur marinetechnic.shop

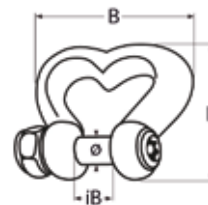

Diamantschäkel, Kettenkreuzschäkel, MT-Serie / A2-AISI 304
Diamond shaped chain cross shackle, MT-series / Manille à chaîne croisée en forme de diamant, MT-série

815251

Artikel-Nr. Item-no.	ø	L	B	iB	Antrieb Drive	Antrieb Drive	Box
815251206	6	34	32	8	TX20 Pin	SW10	10

NEW

Die passenden Bits Art. 815000 im Katalog auf Seite 417 oder unter marinetechnic.shop.
The matching bits Art. 815000 can be found in the catalog on page 417 or at marinetechnic.shop
Les embouts adaptés Art. 815000 dans le catalogue à la page 417 ou sur marinetechnic.shop

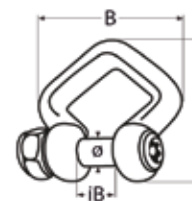

Schnappschäkel mit Wirbelauge / A4-AISI 316
Snap shackle with swivel eye / Mousqueton de drisse avec émerillon à oeil

8252

Artikel-Nr. Item-no.	ø	L	B	iD	iD1	Ausführung Type	**BL kg	Box
82524070FP	5	70	33	12	13	Unverlierbarer Bolzen Fixed pin	790	5
82524087FP	6	87	42	22	16	Unverlierbarer Bolzen Fixed pin	930	5
82524128FP	9	128	58	22	22	Unverlierbarer Bolzen Fixed pin	2000	5

NEW

NEW

NEW

Weitere Größen finden Sie im Katalog auf Seite 92 oder unter marinetechnic.shop
Further sizes can be found in the catalog on page 92 or at marinetechnic.shop
Vous trouverez d'autres tailles dans le catalogue à la page 92 ou sur marinetechnic.shop

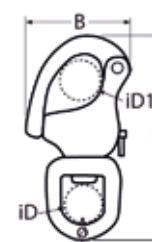

8288

Schnappschäkel / A4-AISI 316
Snap shackle / Mousqueton de drisse

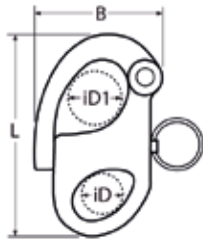

Artikel-Nr. Item-no.	L	B	iD	iD1	Ausführung Type	**BL kg	Box
NEW 8288435FP	35	23	6	9	Unverlierbarer Bolzen Fixed pin	200	5
NEW 8288445FP	45	29	8	10	Unverlierbarer Bolzen Fixed pin	770	5
NEW 8288452FP	52	35	9	13	Unverlierbarer Bolzen Fixed pin	1100	5
NEW 8288466FP	66	45	12	16	Unverlierbarer Bolzen Fixed pin	1430	5
NEW 8288496FP	96	60	16	22	Unverlierbarer Bolzen Fixed pin	1790	5

Weitere Größen finden Sie im Katalog auf Seite 92 oder unter marinetech.shop.
Further sizes can be found in the catalog on page 92 or at marinetech.shop.
Vous trouverez d'autres tailles dans le catalogue à la page 92 ou sur marinetech.shop

8262

Schnappschäkel mit Wirbelschäkel / A4-AISI 316
Snap shackle with swivel shackle / Mousqueton de drisse avec émerillon à chape

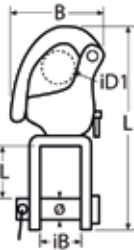

Artikel-Nr. Item-no.	ø	L	iL	B	iB	iD1	Ausführung Type	**BL kg	Box
NEW 82624070FP	5	68	10	33	10	13	Unverlierbarer Bolzen Fixed pin	780	5
NEW 82624087FP	6	87	12	42	12	16	Unverlierbarer Bolzen Fixed pin	910	5
NEW 82624128FP	10	128	20	58	20	22	Unverlierbarer Bolzen Fixed pin	1800	5

Weitere Größen finden Sie im Katalog auf Seite 93 oder unter marinetech.shop.
Further sizes can be found in the catalog on page 93 or at marinetech.shop.
Vous trouverez d'autres tailles dans le catalogue à la page 93 ou sur marinetech.shop

8289

Schnappschäkel mit Schraube / A4-AISI 316
Snap shackle with screw / Mousqueton de drisse à vis

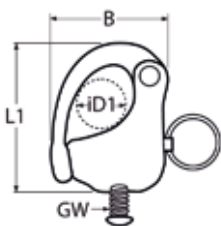

Artikel-Nr. Item-no.	GW	L1	B	iD1	Ausführung Type	**BL kg	Box
NEW 8289406FP	M6	42	30	12	Unverlierbarer Bolzen Fixed pin	650	5
NEW 8289408FP	M8	53	40	16	Unverlierbarer Bolzen Fixed pin	750	5
NEW 8289410FP	M10	75	62	22	Unverlierbarer Bolzen Fixed pin	1600	5

Weitere Größen finden Sie im Katalog auf Seite 93 oder unter marinetech.shop.
Further sizes can be found in the catalog on page 93 or at marinetech.shop.
Vous trouverez d'autres tailles dans le catalogue à la page 93 ou sur marinetech.shop

Pelikanhaken mit Innengewinde / A4-AISI 316
Pelican hook with internal thread / Crochet pélican avec filetage interne

8283

Artikel-Nr. Item-no.	GW	L	iD	Ausführung Type	**BL kg	Box	
8283406FP	M6	75	15,0	Unverlierbarer Bolzen Fixed pin	570	1	NEW
8283408FP	M8	100	16,5	Unverlierbarer Bolzen Fixed pin	1030	1	NEW
8283410-125FP	M10	125	20,5	Unverlierbarer Bolzen Fixed pin	1590	1	NEW

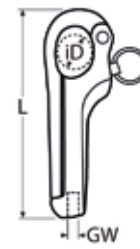

Weitere Größen finden Sie im Katalog auf Seite 124 oder unter marinetechn.shop.

Further sizes can be found in the catalog on page 124 or at marinetechn.shop.

Vous trouverez d'autres tailles dans le catalogue à la page 124 ou sur marinetechn.shop



Edelstahldrahtseil hart/stEIF 1x19 sZ / A4-AISI 316
Wire rope hard/stiff 1x19 sZ / Câble rigide 1x19 sZ

8378

Artikel-Nr. Item-no.	DS-Ø WS-Ø	**BLkg	Haspellänge m Reel length m	
8378401100	1,0	80	100	NEW
83784015100	1,5	180	100	NEW
8378402100	2,0	330	100	NEW
83784025100	2,5	520	100	NEW
8378403100	3,0	750	100	NEW
8378404100	4,0	1340	100	NEW
8378405100	5,0	2100	100	NEW
8378406100	6,0	3020	100	NEW
8378408100	8,0	5380	100	NEW
8378410100	10,0	8400	100	NEW

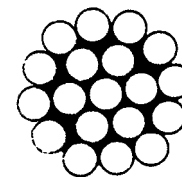

Weitere Größen finden Sie im Katalog auf Seite 129 oder unter marinetechn.shop.

Further sizes can be found in the catalog on page 129 or at marinetechn.shop.

Vous trouverez d'autres tailles dans le catalogue à la page 129 ou sur marinetechn.shop

Edelstahldrahtseil 6x19+PP „Entmistingseil“ / A4-AISI 316
Wire rope 6x19+PP "Manure scraper rope" / Câble 6x19+PP "Câble d'enlèvement" du fumier

815188

Artikel-Nr. Item-no.	DS-Ø WS-Ø	**BLkg	Haspellänge m Reel length m	
815188410250	10	4910	250	

6X19 +PP

NEW

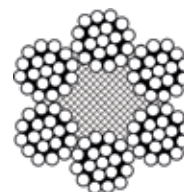

815228

Drahtseilendkappe / PVC
Wire rope protection caps / Capuchons de protection des câbles d'acier

NEW



Artikel-Nr. Item-no.	DS-Ø WR-Ø	H	Box
8152283015	1,5	10	100
8152283020	2,0	10	100
8152283025	2,5	10	100
8152283030	3,0	10	100
8152283040	4,0	10	100
8152283050	5,0	10	100
8152283060	6,0	15	100

8246

Spannschloss / A4-AISI 316
Turnbuckles / Tendeur

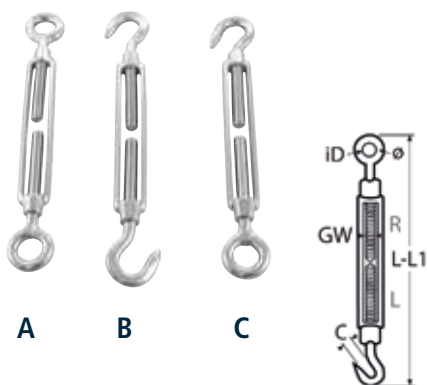

Artikel-Nr. Item-no.	Typ	GW	Ø	L	L1	iD	C	Box
NEW 82464A14	Auge-Auge Eye-Eye	M14	12,6	525	350	22	-	5
NEW 82464B14	Haken-Haken Hook-Hook	M14	12,6	525	350	-	16	5
NEW 82464C14	Auge (rechts)-Haken (links) Eye (right)- hook (left)	M14	12,6	525	350	22	16	5

Weitere Größen finden Sie im Katalog auf Seite 105 oder unter marinetechn.shop.
Further sizes can be found in the catalog on page 105 or at marinetechn.shop.
Vous trouverez d'autres tailles dans le catalogue à la page 105 ou sur marinetechn.shop

8279

Steckbolzen / A4-AISI 316
Clevis pin / Axe pour ridoir

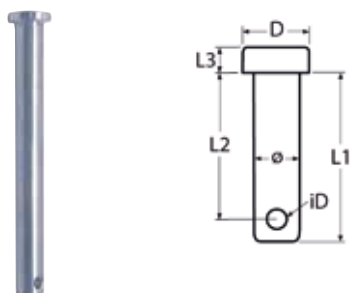

Artikel-Nr. Item-no.	Ø	L1	L2	L3	D	iD	Box
NEW 8279407 33	7	33	30	3,0	10	3	25
NEW 8279411 48	11	48	44	3,5	15	4	10

Weitere Größen von 6x45 bis 16x41 finden Sie im Katalog auf Seite 142/143 oder unter marinetechn.shop.
Further sizes from 6x45 to 16x41 can be found in the catalog on page 142/143 or at marinetechn.shop.
Vous trouverez d'autres tailles de 6x45 à 16x41 dans le catalogue à la page 142/143 ou sur marinetechn.shop

8418

Spannschlossmutter ähnl. DIN 1478 / A4-AISI 316
Turnbuckle body similar to DIN 1478 / Corps de ridoir similaire DIN 1478

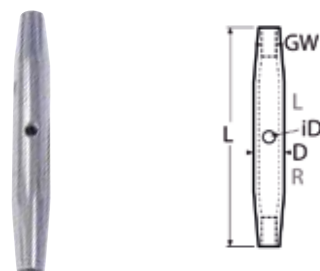

Artikel-Nr. Item-no.	GW	L	D	iD	Box
NEW 8418422	M22	270	40	8	1
NEW 8418424	M24	320	42	10	1

Weitere Größen finden Sie im Katalog auf Seite 104 oder unter marinetechn.shop.
Further sizes can be found in the catalog on page 104 or at marinetechn.shop.
Vous trouverez d'autres tailles dans le catalogue à la page 104 ou sur marinetechn.shop

Sicherungsring / A4-AISI 316
Cotter ring / Anneau de sécurité

8358

Artikel-Nr. Item-no.	ø	D	Box
8358410	1,5	10	250 NEW
8358416	1,5	16	250 NEW
8358418	1,5	18	250 NEW
8358425	2,0	25	200 NEW

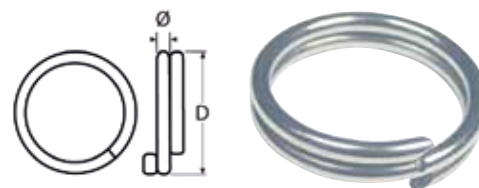

Weitere Größen finden Sie im Katalog auf Seite 146 oder unter marinetech.shop.

Further sizes can be found in the catalog on page 146 or at marinetech.shop.

Vous trouverez d'autres tailles dans le catalogue à la page 146 ou sur marinetech.shop

Gabel mit Rechtsgewinde / A4-AISI 316
Fork with right thread / Chape avec filetage à droite

8386

Artikel-Nr. Item-no.	GW	ø	L1	L2	iL	iB	H	Antrieb Drive	Box
8386420	M20	20	180	115	30	20	45,5	SW30	1 NEW

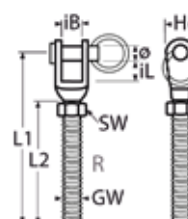

Weitere Größen finden Sie im Katalog auf Seite 101 oder unter marinetech.shop.

Further sizes can be found in the catalog on page 101 or at marinetech.shop.

Vous trouverez d'autres tailles dans le catalogue à la page 101 ou sur marinetech.shop

Gabel mit Linksgewinde / A4-AISI 316
Fork with left thread / Chape avec filetage à gauche

8432

Artikel-Nr. Item-no.	GW	ø	L1	L2	iL	iB	H	Antrieb Drive	Box
8432420	M20	20	180	115	30	20	45,5	SW30	1 NEW

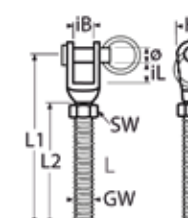

Weitere Größen finden Sie im Katalog auf Seite 101 oder unter marinetech.shop.

Further sizes can be found in the catalog on page 101 or at marinetech.shop.

Vous trouverez d'autres tailles dans le catalogue à la page 101 ou sur marinetech.shop

Decksgelenk mit Gabelkopf, flach / A4-AISI 316
Swivel deck hinge, flat / Platine de capote articulée, plat

815219

NEW

Artikel-Nr. Item-no.	ø	L	L1	B	iB	H	BD	Box
815219431 70	6	70	75	31	7,5	32	6	5



8515

Stockschraube mit Rechtsgewinde / A2-AISI 304 / A4-AISI 316 Hanger bolt with right thread / Goujon avec filetage à droite

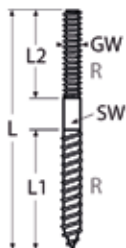

	Artikel-Nr. A4 Item-no. A4	Artikel-Nr. A2 Item-no. A2	GW	L	L1	L2	Antrieb Drive	Box
	8515405 080	NEW 8515205 080	M5	80	32	43	SW3	10
NEW	8515406 050	NEW 8515206 050	M6	50	37	11	–	10
	8515406 060	NEW 8515206 060	M6	60	37	20	–	10
	8515406 070	NEW 8515206 070	M6	70	47	20	–	10
	8515406 080	NEW 8515206 080	M6	80	52	25	–	10
	8515406 090	NEW 8515206 090	M6	90	52	35	–	10
NEW	8515406 100	NEW 8515206 100	M6	100	52	45	–	10
NEW	8515406 120	NEW 8515206 120	M6	120	72	45	–	10
	8515408 060	NEW 8515208 060	M8	60	37	20	–	10
	8515408 070	NEW 8515208 070	M8	70	37	25	–	10
	8515408 080	NEW 8515208 080	M8	80	37	30	SW6	10
	8515408 100	NEW 8515208 100	M8	100	47	40	SW6	10
	8515408 110	NEW 8515208 110	M8	110	47	20	SW6	10
	8515408 120	NEW 8515208 120	M8	120	47	50	SW6	10
	8515408 130	NEW 8515208 130	M8	130	47	50	SW6	10
NEW	8515408 150	NEW 8515208 150	M8	150	47	50	–	10
NEW	8515408 160	NEW 8515208 160	M8	160	62	50	–	10
NEW	8515410 060	NEW 8515210 060	M10	60	37	20	SW8	10
	8515410 080	NEW 8515210 080	M10	80	47	20	SW8	10
	8515410 100	NEW 8515210 100	M10	100	57	30	SW8	10
	8515410 120	NEW 8515210 120	M10	120	57	50	SW8	10
	8515410 140	NEW 8515210 140	M10	140	57	50	SW8	10
	8515410 150	NEW 8515210 150	M10	150	57	50	SW8	10
NEW	8515410 160	NEW 8515210 160	M10	160	57	80	SW8	10

815223

2er-Spanngurtset / A4-AISI 316 / Polyester Strap set of 2 tension straps / Lot de 2 sangles avec 2 boucles

NEW



Artikel-Nr. Item-no.	Inhalt Content	L	B	Box
8152234252300SET*	2 Spanngurte 2 Tension straps	2300	25	1

*Ersatz für 8823425.
*Replacement for 8823425.
*Remplacement de 8823425.

815275

2er-Zurrgurtset mit Klemmschloss, LC 225 daN / A4-AISI 316 / Polyester Strap set of 2 tension straps / Lot de 2 sangles avec 2 boucles

NEW



Artikel-Nr. Item-no.	Inhalt Content	L	B	Box
8152754253500SET	2 Zurrgurte 2 Tension straps	3500	25	1

Zurrkraft direkt LC (daN) / Lashing capacity direct LC (daN)= 225
Zurrkraft Umreifung LC (daN) / Lashing capacity strapping LC (daN)= 450
nicht zum Heben / not for lifting

Batteriehaltergurt-Set / A4-AISI 316 / Polyester
Battery strap set / Lot de sangle pour maintien de batterie

815224

NEW

Artikel-Nr. Item-no.	Für Ø For Ø	L	B	Box
815224425SET*	25mm	960	25	1



Gurtband-Halter-Set für Rettungsinseln und Tanks, MT-Serie / A4-AISI 316 / PES
Strap holder set for life rafts and tanks, MT-series / Kit de support de sangle pour radeaux de survie et réservoirs, MT- série

815252

NEW

Artikel-Nr. Item-no.	Inhalt Content	L	B	B1	H	S	BD	Box
815252425	4 Halter + 2 Zurrgurte 25x3500 4 Brackets + 2 tension straps 25x3500	90	55	28	55	4	6,4	1

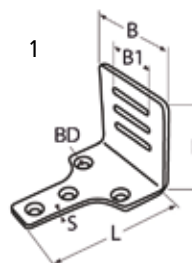

Klappauge / A4-AISI 316
Foldable pad eye / Cadène articulée

815264

NEW

Artikel-Nr. Item-no.	S	L	B	B1	BD	Box
8152644060	6,0	51	48	44	6	5
8152644075	7,5	63	59	55	8	5

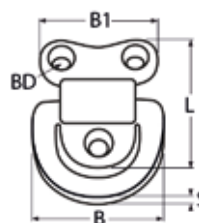

Bimini-Gelenk / A4-AISI 316
Bimini-joint / Joint bimini

815271

NEW

Artikel-Nr. Item-no.	Für Rohr-Ø For tube-Ø	L	L1	Box
815271422	22	80	40	1
815271425	25	80	40	1

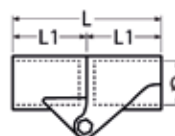

8478

Rohrmittelstück, 2-tlg. / A4-AISI 316
Top slide, 2-part / / Collier ouvrant avec goupille et charnière

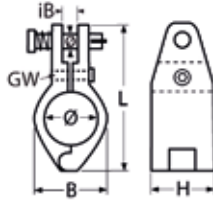

NEW

Artikel-Nr. Item-no.	Für Rohr-Ø For tube-Ø	L	B	iB	H	Ø	GW	Box
8478432	32	73	40	7,5	28	6	M6	5

Weitere Größen finden Sie im Katalog auf Seite 187 oder unter marinotech.shop.
Further sizes can be found in the catalog on page 187 or at marinotech.shop.
Vous trouverez d'autres tailles dans le catalogue à la page 187 ou sur marinotech.shop

815218

Kettenfanghaken mit Auge / A4-AISI 316
Clevis grab hook with eye / Croc de palan pour chaîne avec œil

NEW



Artikel-Nr. Item-no.	Für Kette-Ø For chain-Ø	L	L1	iD	C	**BLkg	Box
815218406	6	75	49	13	9	1800	5
815218408	8	88	57	15	11	2800	5
815218410	10	101	65	18	12	4000	5

815226

Kettenkralle kurz mit großem Ring, MT-Serie / A4-AISI 316
Chain claw short with large ring, MT-series / Griffe pour chaîne courte avec grande anneau, MT-série



NEW

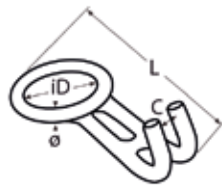

Artikel-Nr. Item-no.	Für Kette-Ø For chain-Ø	Ø	L	iD	C	Box
815226408	6-8	7	105	40	9	5
815226410	8-10	10	135	50	12	5

815270

Kettenschäkel, MT-Serie / A4-AISI 316
Chain shackle, MT-series / Manille de chaîne, MT-série



NEW

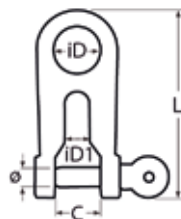

Artikel-Nr. Item-no.	Für Kette-Ø For chain-Ø	Ø	L	C	iD	iD1	Box
815270406 08	6-8	8	75	17,5	18,8	9,8	1
815270410 13	10-13	12	112	26,4	28,0	14,2	1

Rundstahlkette ähnl. EN 818-2 / A2-AISI 304
Chain similar to EN 818-2 / Chaîne similaire à EN 818-2

815229

NEW

Artikel-Nr. Item-no.	ø	iL	B	**BLkg	Bund m Bundle m
815229207	7	21	25,9	2300	50



Rundstahlkette kurzglied, ähnlich DIN 766 / A2-AISI 304
Chain short-link, similar to DIN 766 / Chaîne maillon court similaire à DIN 766

8300

Artikel-Nr. Item-no.	ø	iL	B	**BLkg	Bund m Bundle m
8300207	7	22	23	2440	50

NEW

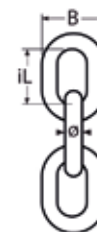

Weitere Größen finden Sie im Katalog auf Seite 218 oder unter marinetech.shop.
Further sizes can be found in the catalog on page 218 or at marinetech.shop.
Vous trouverez d'autres tailles dans le catalogue à la page 218 ou sur marinetech.shop

Rundstahlkette Langglied, ähnlich DIN 763 / A4-AISI 316
Chain long-link, similar to DIN 763 / Chaîne maillon long similaire à DIN 763

8301

Artikel-Nr. Item-no.	ø	iL	B	**BLkg	Bund m Bundle m
8301404600	4	32	16	610	600
8301405600	5	35	20	1000	600
8301406600	6	42	24	1250	600
8301408350	8	52	32	2500	350

NEW

NEW

NEW

NEW



Weitere Größen finden Sie im Katalog auf Seite 219 oder unter marinetech.shop.
Further sizes can be found in the catalog on page 219 or at marinetech.shop.
Vous trouverez d'autres tailles dans le catalogue à la page 219 ou sur marinetech.shop



Rundschäkel mit Splint, GK6 / D6-AISI 318 LN
D-shackle with split pin, grade 60 / Manille avec goupille, grade 6

815113

Artikel-Nr. Item-no.	ø	ø1	iL	iB	AI kg WLL kg	**BLkg	Box
815113446200050	10	10	33	18	500	2500	1
815113446200125	14	14	40	25	1250	6250	1
815113446200200	18	18	60	32	2000	10000	1
815113446200320	22	22	78	41	3200	16000	1
815113446200500	33	33	109	56	5000	25000	1
815113446200800	38	38	131	66	8000	40000	1
815113446201300	39	39	152	76	13000	65000	1

NEW

NEW

NEW

NEW

NEW

NEW

NEW

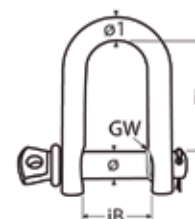

815260

Stellacht / A2-AISI 304
Rope length adjuster / Ajusteur de longueur de corde

NEW



Artikel-Nr. Item-no.	ø	L	iD	Box
815260206 60	6	60	14	10
815260206 70	6	70	18	10
815260208 80	8	80	18	10

815051

Scharnier / A4L-AISI 316L
Hinge / Charnière

NEW

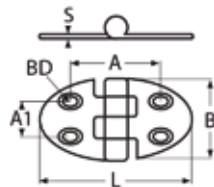

Artikel-Nr. Item-no.	L	B	A	A1	S	BD	Box
815051454 34	54	34	33	15	2	5,2	2

815181

Scharnier / A2-AISI 304
Hinge / Charnière

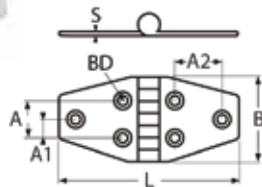

NEW

Artikel-Nr. Item-no.	L	B	S	A	A1	A2	BD	Box
815181270 40	70	40	1,5	19	9,5	18	4,7	2

8384

Kabinenhaken / A4-AISI 316
Cabin hook / Crochet de cabine

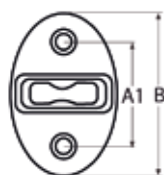

NEW

Artikel-Nr. Item-no.	B	A1	Box
83844BRACKET	37,5	26,5	1

Zusatzhalterung für Kabinenhaken
Additional bracket for cabin hooks
Support supplémentaire pour crochet de cabine



D-Ring gebogen / A4L-AISI 316L
D-ring bended / Anneau en D courbé

815227

NEW

Artikel-Nr. Item-no.	ø	W	iL	iB	Box
81522745040135	5,0	135°	40	33	10
81522745250143	5,2	143°	50	39	10

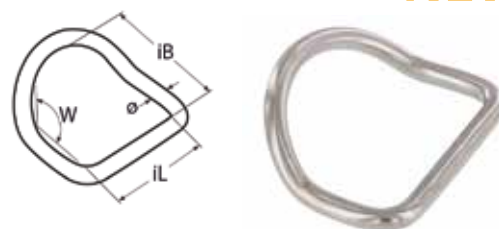

D-Ring / A4-AISI 316
D-ring / Anneau en D

8274

Artikel-Nr. Item-no.	ø	iL	iB	Box
8274403 25	3	25	22	10
8274403 30	3	30	27	10
8274404 35	4	35	32	10
8274404 40	4	40	37	10
8274405 40	5	40	37	10
8274405 50	5	50	47	10

NEW
NEW
NEW
NEW
NEW
NEW

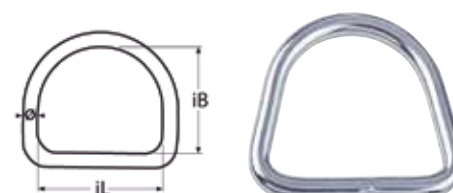

Weitere Größen finden Sie im Katalog auf Seite 297 oder unter marinetech.shop.

Further sizes can be found in the catalog on page 297 or at marinetech.shop.

Vous trouverez d'autres tailles dans le catalogue à la page 297 ou sur marinetech.shop

D-Ring Doppelsteg / A4L-AISI 316L
D-ring with double bar / Anneau en D double barrette

815230

NEW

Artikel-Nr. Item-no.	ø	iL	B	iB	iB1	Box
815230244	6,5	44	65	37	7,5	10

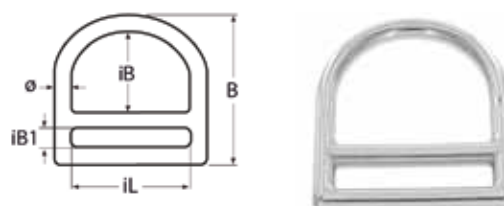

Seilkreuzverbinder / A2-AISI 304
Cross hook for rope / Crochet pour corde

815200

NEW

Artikel-Nr. Item-no.	ø	L	iD	Box
815200216	4,5	45	16	20



815201

Doppelhaken / A2-AISI 304
Double hook / Double crochet

NEW



Artikel-Nr. Item-no.	ø	L	iD	Box
815201216	5	48	16	20

815202

S-Haken 90° / A2-AISI 304
S hook 90° / Crochet en S 90°

NEW



Artikel-Nr. Item-no.	ø	L	iD	Box
815202216	5	48	16	20

815221

Brettschraubenmutter / A4-AISI 316
Carriage nuts / Ecrous de fixation

NEW



Artikel-Nr. Item-no.	GW	Box
815221412	M12	10
815221416	M16	10
815221420	M20	10

Geeignet für die Verschraubung mit Gewindestücken DIN 976
Suitable for screwing with DIN 976 stud bolts
Convient pour le vissage avec des pièces filetées DIN 976

8271

Augbolzen mit Holzgewinde / A4-AISI 316
Eye bolt with wood thread / Piton à oeil avec filetage bois



Artikel-Nr. Item-no.	GW	ø	L1	L2	iD	Box
NEW 8271405 30	M5	4	30	30	11	10

Weitere Größen finden Sie im Katalog auf Seite 350 oder unter marinetechn.shop.
Further sizes can be found in the catalog on page 350 or at marinetechn.shop.
Vous trouverez d'autres tailles dans le catalogue à la page 350 ou sur marinetechn.shop

Augbolzen mit metr. Gewinde und Ring / A4-AISI 316
 Eye bolt with metr. thread and ring / Piton à œil avec filetage métrique et anneau

815268

NEW

Artikel-Nr. Item-no.	GW	ø	L1	L2	iD	**BL kg	Box
815268406 080	M6	5	110	80	25	770	5
815268408 100	M8	6	139	100	40	1390	5
815268410 100	M10	8	148	100	40	2180	5
815268412 120	M12	10	181	120	50	3200	5

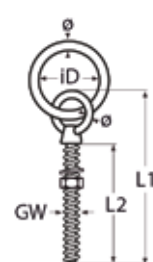

Klampe mit Innengewinde und Alu-Gegenplatte / A4-AISI 316
 Cleat with internal thread and alu counterplate / Taquet avec filetage int. contre-plaque en alu

814858

Artikel-Nr. Item-no.	L	L1	B1	H	A	S	GW	Box
8148584152	152	110	50	36	60	5	M8	10

NEW

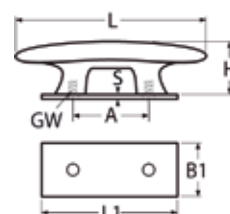

Weitere Größen finden Sie im Katalog auf Seite 306 oder unter marinetechnic.shop.

Further sizes can be found in the catalog on page 306 or at marinetechnic.shop.

Vous trouverez d'autres tailles dans le catalogue à la page 306 ou sur marinetechnic.shop

Antennenfuß mit Grundplatte / A4-AISI 316
 Antenna deck base, long type / Embase d'antenne longue

8604

Artikel-Nr. Item-no.	GW	D	iD	H	H1	S	BD	Box
8604425*	1*	70	18	105	22	3	7	1

NEW

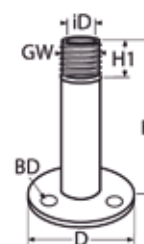

*Ersatz für 8604225.

*Replacement for 8604225.

*Remplacement de 8604225.

815220

Teleskopbadeleiter mit ausklappbaren Griffen / A4-AISI 316
Telescopic bathing ladder with folding handles / Échelle télescopique avec poignées dépliab

NEW

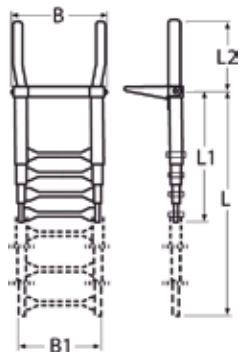

Artikel-Nr. Item-no.	Stufen Steps	L	L1	L2	B	B1	Box
81522044	4	1120	430	305	460	300	1

814272

Kassettenbadeleiter / A4-AISI 316
Telescopic bathing ladder in box / Échelle télescopique escamotable

NEW

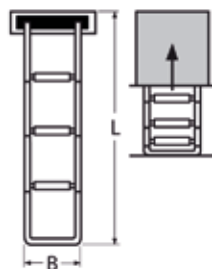

Artikel-Nr. Item-no.	Stufen Steps	L	B	Box
81427243	3	875	264	1
81427244	4	1150	254	1

815222

Teleskop Badeleiter mit Griff für Montage auf Plattform / A4-AISI 316
Telescopic bathing ladder with handle for mounting on platform / *

NEW

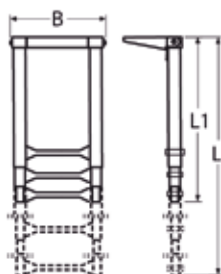

Artikel-Nr. Item-no.	Ausführung Type	Stufen Steps	L	L1	B	Box
81522243BK	Schwarz/Black	3	875	370	305	1
81522243W	Weiß/White	3	875	370	305	1
81522244BK	Schwarz/Black	4	1145	395	305	1
81522244W	Weiß/White	4	1145	395	305	1

*Échelle T télescopique avec poignée pour montage sur plate-forme

Halter für Teleskopbadeleiter / A4-AISI 316
 Console for telescopic bathing ladder / Support pour échelle télescopique

8437

Artikel-Nr. Item-no.		L	iB	A	BD	Box	
843742HOLDER	Passend für / Fits for = 843742	144	30	38	7,2	2	NEW
843743HOLDER	Passend für / Fits for = 843743	178	35	38	7,2	2	NEW
843744HOLDER	Passend für / Fits for = 843744	243	44	38	10,5	2	NEW

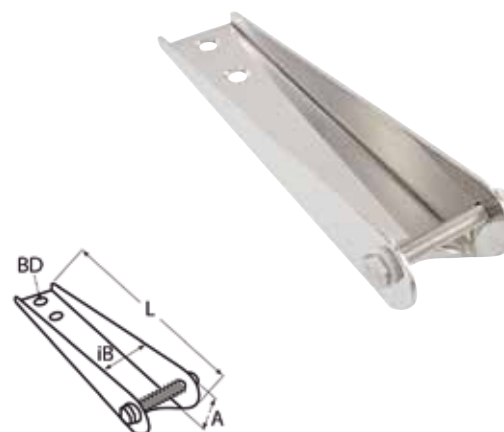

Schwanenhals mit Decksdurchführung und Konterplatte, MT-Serie / A4-AISI 316
 Gooseneck with counter plate, MT-series / Col de cygne avec contre-plaque, MT-séries

815269

NEW

Artikel-Nr. Item-no.	H	H1	B	D	D1	S	S1	Box
815269420	145	175	120	51	20	2,0	2	1
815269440	145	175	128	78	40	2,5	3	1
815269450	166	197	140	78	50	2,5	3	1

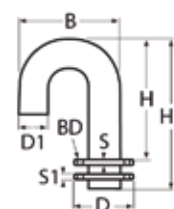

Lenzstopfen, oval mit unverlierbarem Verschluss / A4-AISI 316
 Drain plug, oval with captive closure / Bouchon de nable à visser, ovale avec fermeture imperdable

815272

NEW

Artikel-Nr. Item-no.	L	B	D	BD	Box
815272	50	38	24	5,3	1

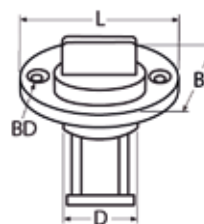

8229

Ring, rund / A4-AISI 316
Ring, round / Anneau rond

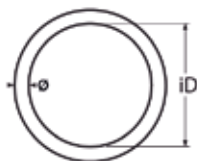

Artikel-Nr. Item-no.	ø	iD	**BL kg	Box
NEW 8229403 15DBK	3	15	250	20
NEW 8229403 25DBK	3	25	250	20
NEW 8229404 25DBK	4	25	440	20
NEW 8229405 30DBK	5	30	690	10

Weitere Größen finden Sie im Hauptkatalog auf Seite 296 oder unter marinetech.shop.

Further sizes can be found in the main catalog on page 296 or at marinetech.shop.

Vous trouverez d'autres tailles dans le catalogue général à la page 296 ou sur marinetech.shop.

8246

Spannschloss / A4-AISI 316
Turnbuckle / Tendeur



A B C



Artikel-Nr. Item-no.	GW	ø	L	L1	iD	C	**BL kg Typ A	Box
NEW 82464*A*B*C05DBK	M5	4,4	165	112	8	7,5	550	5
NEW 82464*A*B*C06DBK	M6	5,3	210	145	10	9,0	750	5
NEW 82464*A*B*C08DBK	M8	7,1	280	190	14	12,0	1300	5
NEW 82464*A*B*C10DBK	M10	8,9	345	240	16	13,0	2000	5

Weitere Größen finden Sie im Hauptkatalog auf Seite 105 oder unter marinetech.shop.

Further sizes can be found in the main main catalog on page 105 or at marinetech.shop.

Vous trouverez d'autres tailles dans le catalogue général à la page 105 ou sur marinetech.shop.

8247

Kausche, schwere Ausführung / A4-AISI 316
Thimble, heavy duty / Cosse cœur arrondie

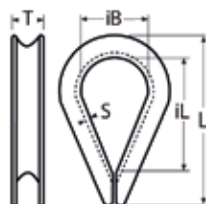

Artikel-Nr. Item-no.	DS-Ø WR-Ø	L	iL	iB	T	S	Box
NEW 8247403DBK	3	26	18	11	6	2,0	50
NEW 8247404DBK	4	32	21	14	7	3,0	50
NEW 8247405DBK	5	42	28	15	9	4,5	50
NEW 8247406DBK	6	43	28	17	11	2,6	50
NEW 8247408DBK	8	58	43	24	10	3,2	25
NEW 8247410DBK	10	68	51	28	13	5,0	10

Weitere Größen finden Sie im Hauptkatalog auf Seite 132 oder unter marinetech.shop.

Further sizes can be found in the main catalog on page 132 or at marinetech.shop.

Vous trouverez d'autres tailles dans le main catalogue général à la page 132 ou sur marinetech.shop.



Drahtseilklemme / A4-AISI 316
Wire rope clip / Serre-câble étrier

8248

Artikel-Nr. Item-no.	DS-Ø WR-Ø	GW	Antrieb Drive	Box	
8248402DBK	2	M3	SW5,5	25	NEW
8248403DBK	3	M3	SW5,5	25	NEW
8248404DBK	4	M4	SW7	25	NEW
8248405DBK	5	M5	SW8	25	NEW
8248406DBK	6	M6	SW10	10	NEW
8248408DBK	8	M6	SW10	10	NEW
8248410DBK	10	M8	SW13	5	NEW

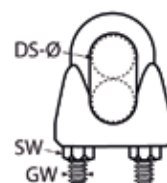

Technische Informationen
Technical information
Informations techniques

DS-Ø = max. Drahtseildurchmesser. Bei Drahtseil-Zwischengrößen ist die nächstgrößere Drahtseilklemme zu wählen.
WR-Ø = max. wire rope diameter. Wire ropes with intermediate diameters must be fixed with the next larger wire rope clip.
DS-Ø / WR-Ø = diamètre maximal du câble. Les câbles d'acier de diamètre intermédiaire doivent être fixés à l'aide de la pince à câble de taille immédiatement supérieure.

Weitere Größen finden Sie im Hauptkatalog auf Seite 135 oder unter marinetech.shop.
Further sizes can be found in the main main catalog on page 135 or at marinetech.shop.
Vous trouverez d'autres tailles dans le catalogue général à la page 135 ou sur marinetech.shop.



Karabinerhaken / A4-AISI 316
Spring hook / Mousqueton pompier

8249

Artikel-Nr. Item-no.	ø	L	iD	iD1	C	iB	**BL kg	Box	
8249403 30DBK	3	30	5	8	5	4	140	20	NEW
8249404 40DBK	4	40	9	12	7	5	260	20	NEW
8249405 50DBK	5	50	10	15	8	6	390	20	NEW
8249406 60DBK	6	60	11	18	9	8	450	20	NEW
8249408 80DBK	8	80	13	24	9	8	640	10	NEW

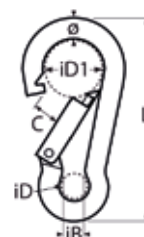

Weitere Größen finden Sie im Hauptkatalog auf Seite 68 oder unter marinetech.shop.
Further sizes can be found in the main main catalog on page 68 or at marinetech.shop.
Vous trouverez d'autres tailles dans le catalogue général à la page 68 ou sur marinetech.shop.



Edelstahldrahtseil mittelweich 7x7 sZ / A4-AISI 316
Wire rope semi-soft 7x7 sZ / Câble souple 7x7 sZ

8379

Artikel-Nr. Item-no.	DS-Ø WR-Ø	**BL kg	Haspellänge m Reel length m	
8379402250BK	2	230	250	NEW
8379403250BK	3	510	250	NEW
8379404250BK	4	910	250	NEW
8379405250BK	5	1430	250	NEW
8379406100BK	6	2060	100	NEW
8379408100BK	8	3670	100	NEW
8379410100BK	10	5740	100	NEW

7x7

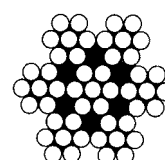

Weitere Größen finden Sie im Hauptkatalog auf Seite 354 oder unter marinetech.shop.
Further sizes can be found in the main catalog on page 354 or at marinetech.shop.
Vous trouverez d'autres tailles dans le catalogue général à la page 354 ou sur marinetech.shop.

8253

Schraubverbinder / A4-AISI 316
Quick link / Maillon à visser



Artikel-Nr. Item-no.	ø	iL	iB	C	Antrieb Drive	**BL kg	Box
NEW 8253404DBK	4	32	12,0	5,5	SW8	500	20
NEW 8253405DBK	5	39	13,0	6,5	SW9	790	20
NEW 8253406DBK	6	45	14,5	7,5	SW10	1130	10
NEW 8253408DBK	8	58	17,5	10,0	SW13	2000	10
NEW 8253410DBK	10	72	21,0	12,0	SW15	3100	5

Weitere Größen finden Sie im Hauptkatalog auf Seite 74 oder unter marinotech.shop.

Further sizes can be found in the main catalog on page 74 or at marinotech.shop.

Vous trouverez d'autres tailles dans le catalogue général à la page 74 ou sur marinotech.shop.

8258

Rundschäkel / A4-AISI 316
D-shackle / Manille droite

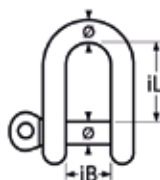

Artikel-Nr. Item-no.	ø	iL	iB	**BL kg	Box
NEW 8258404DBK	4	14,0	8	700	20
NEW 8258405DBK	5	17,5	10	1000	20
NEW 8258406DBK	6	21,0	12	1500	20
NEW 8258408DBK	8	28,0	16	3000	20
NEW 8258410DBK	10	35,0	20	4300	20

Weitere Größen finden Sie im Hauptkatalog auf Seite 84 oder unter marinotech.shop.

Further sizes can be found in the main catalog on page 84 or at marinotech.shop.

Vous trouverez d'autres tailles dans le catalogue général à la page 84 ou sur marinotech.shop.

8260

Rundschäkel, geschweif / A4-AISI 316
Bow shackle / Manille lyre

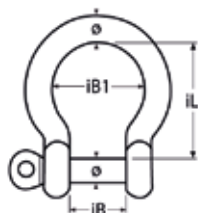

Artikel-Nr. Item-no.	ø	iL	iB	iB1	**BL kg	Box
NEW 8260404DBK	4	14,0	8	14	800	20
NEW 8260405DBK	5	17,0	10	17	1200	20
NEW 8260406DBK	6	21,0	12	21	1800	20
NEW 8260408DBK	8	28,0	16	28	2800	10
NEW 8260410DBK	10	35,0	20	35	4300	10

Weitere Größen finden Sie im Hauptkatalog auf Seite 88 oder unter marinotech.shop.

Further sizes can be found in the main catalog on page 88 or at marinotech.shop.

Vous trouverez d'autres tailles dans le catalogue général à la page 88 ou sur marinotech.shop.



Ringmutter gegossen ähnlich DIN 582 / A4-AISI 316
 Eye nut cast similar to DIN 582 / Ecrou à anneau moule similaire DIN 582

8268

Artikel-Nr. Item-no.	GW	iD	D	L	Box
8268405DBK	M5	12,5	22,5	23,5	10
8268406DBK	M6	16,0	28,0	28,0	10
8268408DBK	M8	20,0	36,0	33,0	10
8268410DBK	M10	25,0	45,0	42,0	5

NEW
NEW
NEW
NEW

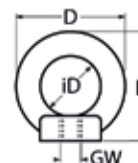

Weitere Größen finden Sie im Hauptkatalog auf Seite 353 oder unter marinetechnology.com.
 Further sizes can be found in the main catalog on page 353 or at marinetechnology.com.
 Vous trouverez d'autres tailles dans le catalogue général à la page 353 ou sur marinetechnology.com.



Ringschraube gegossen, ähnlich DIN 580 / A4-AISI 316
 Eye bolt cast similar to DIN 580 / Vis à anneau moule similaire DIN 580

8272

Artikel-Nr. Item-no.	GW	iD	D	L1	L2	Box
8272405DBK	M5	12,5	22,5	23	11	10
8272406DBK	M6	16,0	28,0	28	11	10
8272408DBK	M8	20,0	36,0	33	13	10
8272410DBK	M10	25,0	45,0	42	17	5

NEW
NEW
NEW
NEW

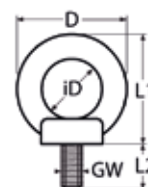

Weitere Größen finden Sie im Hauptkatalog auf Seite 354 oder unter marinetechnology.com.
 Further sizes can be found in the main catalog on page 354 or at marinetechnology.com.
 Vous trouverez d'autres tailles dans le catalogue général à la page 354 ou sur marinetechnology.com.



Klampe mit Innengewinde / A4-AISI 316
 Cleat with internal thread / Taquet avec filetage intérieur

8680

Artikel-Nr. Item-no.	L	L1	B	B1	H	A	S	GW	Box
86804150 30B	150	90	30	19	45	47,4	5	M8	1
86804200 35B	200	120	35	22	54	70,5	5	M10	1
86804250 40B	265	150	40	29	70	83,0	8	M12	1
86804300 50B	300	160	49	38	80	85,0	10	M16	1

NEW
NEW
NEW
NEW

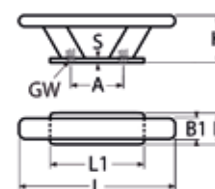

Weitere Größen finden Sie im Hauptkatalog auf Seite 305 oder unter marinetechnology.com.
 Further sizes can be found in the main catalog on page 305 or at marinetechnology.com.
 Vous trouverez d'autres tailles dans le catalogue général à la page 305 ou sur marinetechnology.com.

815095

Tenax Oberteil, großer Knopf
Tenax upper part, big knob / Bouton Tenax partie supérieure



Artikel-Nr. Item-no.	Gewindelänge Length of thread	Ausführung Type	Box
8150957GROSS-SCHWARZ	4,9	Messing schwarz verchromt Brass, chrome plated black Laiton chromé noir	50

Werkzeug: 815097 und 816003 / Tool: 815097 and 816003 / Outil: 815097 et 816003

Weitere Größen finden Sie im Hauptkatalog auf Seite 152 oder unter marinetch.shop.

Further sizes can be found in the main catalog on page 152 or at marinetch.shop.

Vous trouverez d'autres tailles dans le catalogue général à la page 152 ou sur marinetch.shop.

816000

Tenax-Knopf Oberteil mit Ring
Tenax knob upper part with ring / Bouton Tenax avec bague



Artikel-Nr. Item-no.	Gewindelänge Length of thread	Ausführung Type	Box
8160007RS	4,9	Messing schwarz verchromt Brass, chrome plated black Laiton chromé noir	50

Werkzeug: 815097 und 816003 / Tool: 815097 and 816003 / Outil: 815097 et 816003

Weitere Größen finden Sie im Hauptkatalog auf Seite 152 oder unter marinetch.shop.

Further sizes can be found in the main catalog on page 152 or at marinetch.shop.

Vous trouverez d'autres tailles dans le catalogue général à la page 152 ou sur marinetch.shop.

815099

Metrische Schraube für Tenax-Knopf
Tapping screw for Tenax-knob / Vis à tôle pour bouton Tenax



Artikel-Nr. Item-no.	GW	L1	Ausführung Type	Antrieb Drive	Box
815099710VER-SCHWARZ	M5	10	Messing schwarz verchromt Brass, chrome plated black Laiton chromé noir	SW9	50

Weitere Größen finden Sie im Hauptkatalog auf Seite 152 oder unter marinetch.shop.

Further sizes can be found in the main catalog on page 152 or at marinetch.shop.

Vous trouverez d'autres tailles dans le catalogue général à la page 152 ou sur marinetch.shop.



Tenax Unterteil zum Verschrauben

Tenax lower part for screw fixing / Bouton Tenax plaquette partie inférieure à visser

816002

Artikel-Nr. Item-no.	L	B	H	A	BD	Ausführung Type	Box
816002727 11SCHWARZ	27	11	9	15,1	4,9	Messing schwarz verchromt Brass, chrome plated black Laiton chromé noir	50



Passend für Linsensenk-Blechschauben DIN 7983, ISO 14587 3,5mm oder Linsensenk-Holzschrauben DIN 7995 3,5mm.

For countersunk tapping screws DIN 7983, ISO 14587 3.5mm or countersunk wood screws DIN 7995 3.5mm.

Approprié pour les vis à tête fraisée bombée DIN 7983, ISO 14587 3,5mm ou vis à bois à tête fraisée DIN 7995 3,5mm.

Weitere Größen finden Sie im Hauptkatalog auf Seite 153 oder unter marinetech.shop.

Further sizes can be found in the main catalog on page 153 or at marinetech.shop.

Vous trouverez d'autres tailles dans le catalogue général à la page 153 ou sur marinetech.shop.

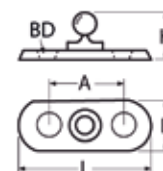

Kunststoff-Scharnier, quadratisch / A4-AISI 316 / PA

Plastic hinge, square / Charnière en plastique, carrée

815079

Artikel-Nr. Item-no.	L	B	H	A	S	BD	Box
815079330 30	30	30	7,0	18	3,0	3,2	10
815079340 40	40	40	10,2	25	5,2	5,3	6
815079350 50	50	50	11,9	30	5,9	6,4	2
815079360 60	60	60	13,5	36	6,5	6,4	2

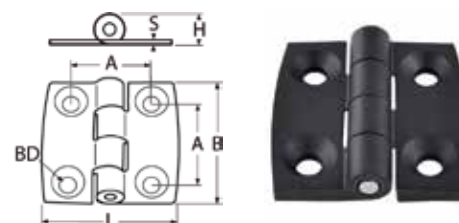

Die Scharniere bestehen aus Polyamid mit 30% Glasfaseranteil. Die Stifte bestehen aus Edelstahl A4 AISI-316.

The hinges are made of polyamide with 30% of glass fibre. The pins are made of stainless steel A4 AISI-316.

Les charnières sont en polyamide fibre de verre 30%, les broches sont en inox A4 AISI-316.



Kunststoff-Scharnier, symmetrisch / A4-AISI 316 / PA

Plastic hinge, symmetrical / Charnière en plastique, symétrique

815080

Artikel-Nr. Item-no.	L	B	H	A	A1	A2	S	BD	Box
815080340 080	80	40	10,2	19	13,5	25	5,2	5,3	2
815080340 120	120	40	10,2	38	14,5	25	5,2	5,3	2
815080350 100	100	50	11,9	24	16,0	30	5,9	6,4	2
815080360 120	120	60	13,5	30	18,0	36	6,5	6,4	2



Die Scharniere bestehen aus Polyamid mit 30% Glasfaseranteil. Die Stifte bestehen aus Edelstahl A4 AISI-316.

The hinges are made of polyamide with 30% of glass fibre. The pins are made of stainless steel A4 AISI-316.

Les charnières sont en polyamide fibre de verre 30%, les broches sont en inox A4 AISI-316.

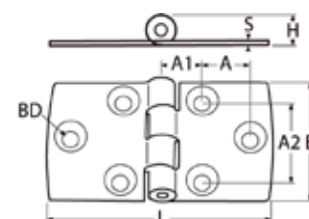

815081

Kunststoff-Scharnier, asymmetrisch / A4-AISI 316 / PA
 Plastic hinge, asymmetrical / Charnière en plastique, asymétrique

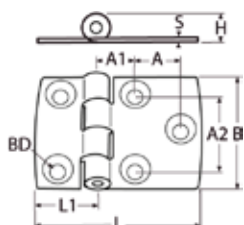

Artikel-Nr. Item-no.	L	L1	B	H	A	A1	A2	S	BD	Box
815081340 60	60	20	40	10,2	19	13,0	25	5,2	5,3	6
815081340 80	80	20	40	10,2	38	13,5	25	5,2	5,3	2
815081350 75	75	25	50	11,9	24	15,5	30	5,9	6,4	2
815081360 90	90	30	60	13,5	30	18,0	36	6,5	6,4	2

Die Scharniere bestehen aus Polyamid mit 30% Glasfaseranteil. Die Stifte bestehen aus Edelstahl A4 AISI-316.

The hinges are made of polyamide with 30% of glass fibre. The pins are made of stainless steel A4 AISI-316.

Les charnières sont en polyamide fibre de verre 30%, les broches sont en inox A4 AISI-316.

814738

Scharnier mit Abdeckung / Plastik, schwarz
 Covered hinge, Plastic, black / Charnière avec cache de vis en plastique, noir

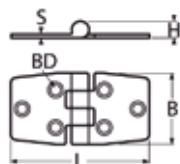

Artikel-Nr. Item-no.	L	B	H	S	BD	Box
814738379 41	79	41	11	4	4,5	4

814740

Einlassgriff rund, schwarz / Plastik
 Lifting handle, round, black, plastic / Poignée de levage, ronde, noir, plastique



Artikel-Nr. Item-no.	D	H	H1	Box
814740351RUND	51	12,5	6	1



Schranktüren-/Schubladen-Griff / A4-AISI 316
Drawer or cabinet handle / Poignée de porte ou de tiroir

815050

Artikel-Nr. Item-no.	Ausführung Type	L	B	H	iH	A	GW	Box
8150504152DB	Schwarz matt Dull black	152	20	30	24	138	M5	1
8150504152GB	Schwarz glanz Glossy black	152	20	30	24	138	M5	1



8150504152GB
8150504152DB

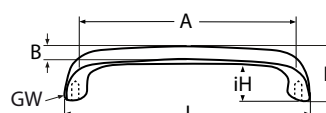

Weitere Größen finden Sie im Hauptkatalog auf Seite 301 oder unter marinetech.shop.

Further sizes can be found in the main catalog on page 301 or at marinetech.shop.

Vous trouverez d'autres tailles dans le catalogue général à la page 301 ou sur marinetech.shop.



Tankentlüfter, 90° / Plastik
Tank vent, 90° / Aération pour réservoir, 90°

814719

Artikel-Nr. Item-no.	Für Schlauch-Ø For hose-Ø	L	L1	D	D1	Antrieb Drive	Box
814719316	16 (5/8")	73	17	32	19	SW24	5

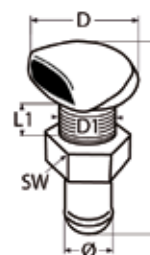

Tankentlüfter / Plastik
Tank vent / Aération pour réservoir

814720

Artikel-Nr. Item-no.	Für Schlauch-Ø For hose-Ø	L	L1	D	D1	Antrieb Drive	Box
814720316	16 (5/8")	78	16	35	19	SW32	5

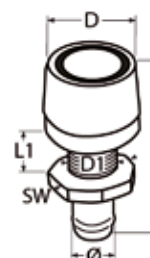

DIN 125

Scheiben Form A / A4-AISI 316
Washers type A / Rondelles forme A

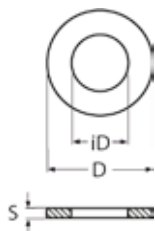

Artikel-Nr. Item-no.	iD	D	S	Box
NEW 0125443CBK-VE100	4,3	9	0,8	100
NEW 0125453CBK-VE100	5,3	10	1,0	100
NEW 0125464CBK-VE100	6,4	12	1,6	100
NEW 0125484CBK-VE100	8,4	16	1,6	100
NEW 01254105CBK-VE100	10,5	20	2,0	100
NEW 01254130CBK-VE100	13,0	24	2,5	100

DIN 9021

Scheiben Außendurchmesser \approx 3x GW-durchmesser / A4-AISI 316
Washers outside diameter \sim 3 x thread diameter / Rondelle plate large

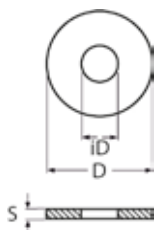

Artikel-Nr. Item-no.	iD	D	S	Box
NEW 9021443CBK-VE100	4,3	12	1,0	100
NEW 9021453CBK-VE100	5,3	15	1,8	100
NEW 9021464CBK-VE100	6,4	18	1,2	100
NEW 9021484CBK-VE100	8,4	24	2,0	100
NEW 90214105CBK-VE100	10,5	30	2,5	100
NEW 90214130CBK-VE100	13,0	37	3,0	100

DIN 9054

Karoscheiben / A4-AISI 316
Penny washers / Rondelles de carrosserie

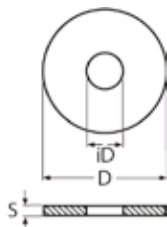

Artikel-Nr. Item-no.	iD	D	S	Box
NEW 9054420 43CBK-VE100	4,3	20	1,25	100
NEW 9054425 53CBK-VE100	5,3	25	1,5	100
NEW 9054430 64CBK-VE100	6,4	30	1,5	100
NEW 9054430 84CBK-VE100	8,4	30	1,5	100
NEW 9054440 105CBK-VE100	10,5	40	1,5	100
NEW 9054440 125CBK-VE100	12,5	40	1,5	100



Senkschrauben mit Innensechsrund / A4-AISI 316
Hexalobular socket countersunk flat head screws / Vis à tête fraisée réduite à six lobes internes

ISO 14581

Artikel-Nr. Item-no.	GW	L	D	H	Antrieb Drive	Box
1458144 20CBK-VE100	M4	20	8,4	2,7	TX20	100
1458144 30CBK-VE100	M4	30	8,4	2,7	TX20	100
1458144 40CBK-VE100	M4	40	8,4	2,7	TX20	100
1458145 30CBK-VE100	M5	30	9,3	2,7	TX25	100
1458145 40CBK-VE100	M5	40	9,3	2,7	TX25	100
1458145 60CBK-VE100	M5	60	9,3	2,7	TX25	100
1458146 40CBK-VE100	M6	40	11,3	3,3	TX30	100
1458146 50CBK-VE100	M6	50	11,3	3,3	TX30	100
1458146 60CBK-VE100	M6	60	11,3	3,3	TX30	100



Sechskantschrauben mit Vollgewinde / A4-AISI 316
Hexagon head screws / Vis métaux TH filetage total

DIN 933

Artikel-Nr. Item-no.	GW	L	H	Antrieb Drive	Box
093344 20CBK-VE100	M4	20	2,8	SW7	100
093344 30CBK-VE100	M4	30	2,8	SW7	100
093344 40CBK-VE100	M4	40	2,8	SW7	100
093345 20CBK-VE100	M5	20	3,5	SW8	100
093345 30CBK-VE100	M5	30	3,5	SW8	100
093345 40CBK-VE100	M5	40	3,5	SW8	100
093346 30CBK-VE100	M6	30	4,0	SW10	100
093346 40CBK-VE100	M6	40	4,0	SW10	100
093346 50CBK-VE100	M6	50	4,0	SW10	100

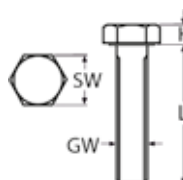

Sechskantmuttern / A4-AISI 316
Hexagon nuts / Écrous hexagonaux

DIN 934

Artikel-Nr. Item-no.	GW	H	Antrieb Drive	Box
093444CBK-VE100	M4	3,2	SW7	100
093445CBK-VE100	M5	4,0	SW8	100
093446CBK-VE100	M6	5,0	SW10	100
093448CBK-VE100	M8	6,5	SW13	100
0934410CBK-VE100	M10	8,0	SW17	100
0934412CBK-VE100	M12	10,0	SW19	100

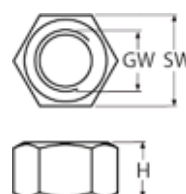

DIN 6923

Sechskantmuttern m. Flansch o. Sperrverzahnung / A4-AISI 316

Hexagon flange nuts without serration / Écrous hexagonaux à embase lisse

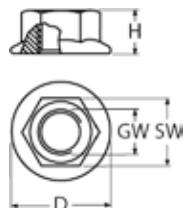

Artikel-Nr. Item-no.	GW	D	H	Antrieb Drive	Box
NEW 6923404CBK-VE100	M4	10,0	10,0	SW7	100
NEW 6923405CBK-VE100	M5	11,8	12,0	SW8	100
NEW 6923406CBK-VE100	M6	14,2	4,65	SW10	100
NEW 6923408CBK-VE100	M8	17,9	5,0	SW13	100
NEW 69234010CBK-VE100	M10	21,8	6,0	SW17	100
NEW 69234012CBK-VE100	M12	26,0	8,0	SW19	100

DIN 1587

Sechskant-Hutmuttern, hohe Form / A4-AISI 316

Turned hexagon domed cap nuts / Écrous borgnes hexagonaux, forme haute

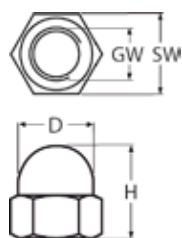

Artikel-Nr. Item-no.	GW	D	H	Antrieb Drive	Box
NEW 158744CBK-VE100	M4	6,5	8	SW7	100
NEW 158745CBK-VE100	M5	7,5	10	SW8	100
NEW 158746CBK-VE100	M6	9,5	12	SW10	100
NEW 158748CBK-VE100	M8	12,5	15	SW13	100
NEW 1587410CBK-VE100	M10	15,0	18	SW17	100
NEW 1587412CBK-VE100	M12	17,0	22	SW19	100

Art. 9047

Seko-Holzbauschrauben, verstärkter Kopf, Vollgewinde / A4-AISI 316

Double countersunk head timber screws w. ribs / Vis TF à bois, nervures de fraisage, tête renforcée

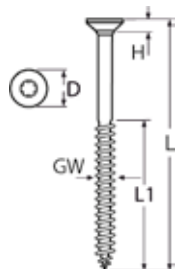

Artikel-Nr. Item-no.	GW	L	D	H	Antrieb Drive	Box
NEW 9047430 16CBK-VE100	3,0	16	6	1,9	TX10	100
NEW 9047430 20CBK-VE100	3,0	20	6	1,9	TX10	100
NEW 9047435 20CBK-VE100	3,5	20	7	2,1	TX15	100
NEW 9047440 25CBK-VE100	4,0	25	8	2,5	TX20	100
NEW 9047440 30CBK-VE100	4,0	30	8	2,5	TX20	100
NEW 9047440 40CBK-VE100	4,0	40	8	2,5	TX20	100
NEW 9047450 30CBK-VE100	5,0	30	10	3,0	TX25	100
NEW 9047450 40CBK-VE100	5,0	40	10	3,0	TX25	100
NEW 9047450 50CBK-VE100	5,0	50	10	3,0	TX25	100



Linsenkopf-Blehschrauben mit Kreuzschlitz / A4-AISI 316
Cross recessed pan head tapping screws / Vis à tôle TCB

DIN 7981

Artikel-Nr. Item-no.	GW	L	D	B	H	Antrieb Drive	Box	
7981435 13CBK-VE100	3,5	13	6,8	4,2	2,6	PH2	100	NEW
7981435 19CBK-VE100	3,5	19	6,8	4,2	2,6	PH2	100	NEW
7981439 13CBK-VE100	3,9	13	7,5	4,4	2,8	PH2	100	NEW
7981439 19CBK-VE100	3,9	19	7,5	4,4	2,8	PH2	100	NEW
7981442 13CBK-VE100	4,2	13	8,1	4,6	3,0	PH2	100	NEW
7981442 25CBK-VE100	4,2	25	8,1	4,6	3,0	PH2	100	NEW
7981448 19CBK-VE100	4,8	19	9,5	5,0	3,5	PH2	100	NEW
7981448 32CBK-VE100	4,8	32	9,5	5,0	3,5	PH2	100	NEW
7981455 32CBK-VE100	5,5	32	10,8	6,5	3,9	PH3	100	NEW

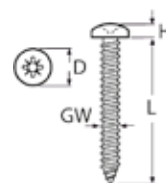

Senk-Blehschrauben mit Kreuzschlitz / A4-AISI 316
Cross recessed countersunk head tapping screws / Vis à tôle à tête fraisée

DIN 7982

Artikel-Nr. Item-no.	GW	L	D	B	H	Antrieb Drive	Box	
7982435 13CBK-VE100	3,5	13	6,8	4,2	2,1	PH2	100	NEW
7982435 19CBK-VE100	3,5	19	6,8	4,2	2,1	PH2	100	NEW
7982439 16CBK-VE100	3,9	13	7,5	4,4	2,3	PH2	100	NEW
7982439 25CBK-VE100	3,9	19	7,5	4,4	2,3	PH2	100	NEW
7982442 16CBK-VE100	4,2	13	8,1	4,6	2,5	PH2	100	NEW
7982442 25CBK-VE100	4,2	25	8,1	4,6	2,5	PH2	100	NEW
7982448 19CBK-VE100	4,8	19	9,5	5,0	3,0	PH2	100	NEW
7982448 32CBK-VE100	4,8	32	9,5	5,0	3,0	PH2	100	NEW
7982455 32CBK-VE100	5,5	32	10,8	6,5	3,4	PH3	100	NEW

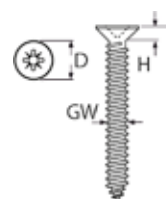

815217

Sortimentskästen

Assortment boxes / Boîtes d'assortiment

Artikel-Nr. Item-no.	Bechreibung Description	Box	Produktbild auf Seite Picture on page
8152171140	Monel-Blindnieten Monel 3,2-4mm, 62-teilig Monel rivets A4 3,2-4mm, 62 parts	1	36
8152171141	Monel-Blindnieten Monel 4,8-6,4mm, 45-teilig Monel rivets A4 4,8-6,4mm, 45 parts	1	36
8152172034	Metrische Ösenschrauben A2 M4x20-M6x40, 60-teilig Metric screw eyes A2 M4x20-M6x40, 60 parts	1	36
8152174010	Karabinerhaken&Verbinder A4 4-8mm, 32-teilig Snap hooks & connectors A4 4-8mm, 32 parts	1	36
8152174011	Simplexhaken&Surf-Snaps A4/A2, 37-teilig Simplex hooks & surf snaps A4, 37 parts	1	36
8152174020	Schäkel A4 4-8mm, 28-teilig Shackles A4 4-8mm, 28 parts	1	36
8152174021	Flachschäkel A4 4-8mm, 27-teilig Flat shackles A4 4-8mm, 27 parts	1	37
8152174030	Bolzen und Splinte A4 4-6mm, 100-teilig Bolts & cotter pins A4 4-6mm, 100 parts	1	37
8152174031	Bolzen und Splinte A4 8-16mm, 48-teilig Bolts & cotter pins A4 8-16mm, 48 parts	1	37
8152174032	Splinte A4, 114-teilig Cotter pins A4, 114 parts	1	37
8152174033	Schraubhaken und -Ösen A4, 51-teilig Screw hooks and screw eyes A4, 51 parts	1	37
8152174040	Fender- und Leitösen A4, 45-teilig Eye straps A4, 45 parts	1	37
8152174110	Spanplattenschrauben Senkkopf TX A4 Art. 9047 3,0-5,0mm, 210-teilig Countersunk head chipboard screws A4 Art.9047 3,0-5,0mm, 210 parts	1	38
8152174110CBK	Spanplattenschrauben Senkkopf TX A4 Art. 9047 3,0-5,0mm, 210-teilig, schwarz Countersunk head chipboard screws A4 Art.9047 3,0-5,0mm, 210 parts, black	1	38
8152174120	Blechschraben Linsen Kopf A4 DIN 7981 3,5-5,5mm, 200-teilig Pan head tapping screws A4 DIN 7981 3,5-5,5mm, 200 parts	1	38
8152174120CBK	Blechschraben Linsen Kopf A4 DIN 7981 3,5-5,5mm, 200-teilig, schwarz Pan head tapping screws A4 DIN 7981 3,5-5,5mm, 200 parts, black	1	38
8152174121	Blechschraben Senkkopf A4 DIN 7982 3,5-5,5mm, 200-teilig Countersunk head tapping screws A4 DIN 7982 3,5-5,5mm, 200 parts	1	38
8152174121CBK	Blechschraben Senkkopf A4 DIN 7982 3,5-5,5mm, 200-teilig, schwarz Countersunk head tapping screws A4 DIN 7982 3,5-5,5mm, 200 parts, black	1	38
8152174130	Metrische Schrauben Zylinderkopf A4 DIN 84 M4-M6, 125-teilig Metric pan had screws A4 DIN 84 M4-M6, 125 parts	1	39
8152174131	Metrische Schrauben Senkkopf A4 DIN 963 M4-M6, 125-teilig Metric countersunk had screws A4 DIN 963 M4-M6, 125 parts	1	39
8152174132	Metrische Senkschrauben TX M4-M6, 150-teilig TX socket countersunk flat head screws, 150 parts	1	39
8152174132CBK	Metrische Senkschrauben TX M4-M6, 150-teilig, schwarz TX socket countersunk flat head screws, 150 parts, black	1	39

Sortimentskästen
Assortment boxes / Boîtes d'assortiment

815217

Artikel-Nr. Item-no.	Bechreibung Description	Box	Produktbild auf Seite Picture on page
8152174133	Metrische Sechskantschrauben M4-M6, 150-teilig Hexagon head screws M4-M6, 150 parts	1	39
8152174133CBK	Metrische Sechskantschrauben M4-M6, 150-teilig, schwarz Hexagon head screws M4-M6, 150 parts, black	1	39
8152174134	Metrische Zylinderschrauben M4-M6, 150-teilig Hexagon socket head cap screws M4-M6, 150 parts	1	40
8152174135	Metrische Flachrundkopfschr. o.Flansch M4-M6, 150-teilig Hexagon socket button head screws, M4-M6, 150 parts	1	40
8152174136	Metrische Flachrundkopfschrauben mit Flansch M4-M6, 150-teilig Hexagon socket button head screws with flange, M4-M6, 150 parts	1	40
8152174150	Unterlegscheiben A4 4,3-6,4mm, 200-teilig Washers A4 4,3-6,4mm, 200 parts	1	40
8152174150CBK	Unterlegscheiben A4 4,3-6,4mm, 200-teilig, schwarz Washers A4 4,3-6,4mm, 200 parts, black	1	40
8152174151	Unterlegscheiben A4 8,4-13,0mm, 100-teilig Washers A4 8,4-13,0mm, 100 parts	1	40
8152174151CBK	Unterlegscheiben A4 8,4-13,0mm, 100-teilig, schwarz Washers A4 8,4-13,0mm, 100 parts, black	1	41
8152174152	Muttern A4 M4-M6, 220-teilig Nuts A4 M4-M6, 220 parts	1	41
8152174153	Muttern A4 M8-M12, 90-teilig Nuts A4 M8-M12, 90 parts	1	41
8152174154CBK	Muttern M4-M6, 270-teilig, schwarz Nuts M4-M6, 270 parts, black	1	41
8152174155CBK	Muttern M8-M12, 90-teilig, schwarz Nuts M8-M12, 90 parts, black	1	41
8152174160	Ringmuttern und Ringschrauben A4 M4-M6, 30-teilig Lifting eye nuts and eye screws A4 M4-M6, 30 parts	1	41
8152174170	Schlauchschellen 10-32mm, 30-teilig Hose clamps 10-32mm, 30 parts	1	42
8152174171	Schlauchschellen 25-70mm, 16-teilig Hose clamps 25-70mm, 16 parts	1	42



815217

Sortimentskästen
Assortment boxes / Boîtes d'assortiment

Beschreibung / Description page 34/35

8152171140



8152174010



8152171141



8152174011



8152172034



8152174020



815217

Sortimentskästen
Assortment boxes / Boîtes d'assortiment

Beschreibung / Description page 34/35

8152174021



8152174032

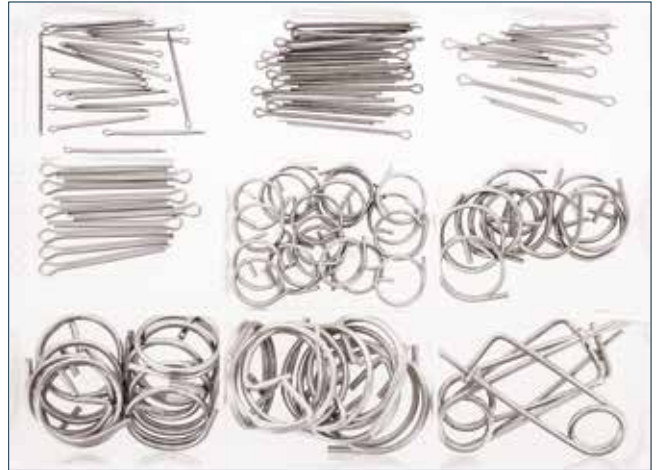

8152174030



8152174033



8152174031



8152174040



815217

Sortimentskästen
Assortment boxes / Boîtes d'assortiment
Beschreibung / Description page 34/35

8152174110

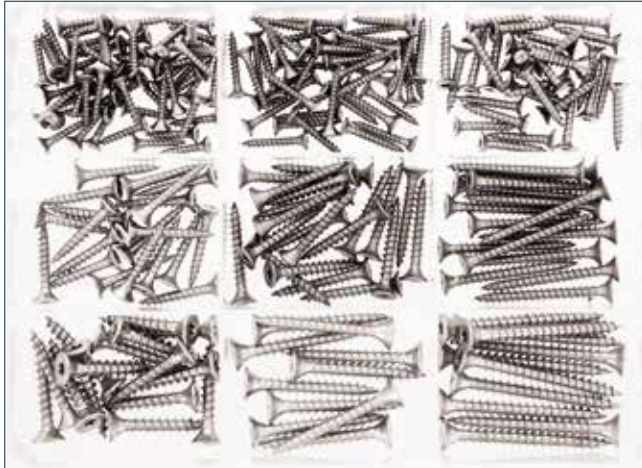

8152174120CBK



8152174110CBK



8152174121



8152174120



8152174121CBK



815217

Sortimentskästen

Assortment boxes / Boîtes d'assortiment

Beschreibung / Description page 34/35

8152174130



8152174132CBK

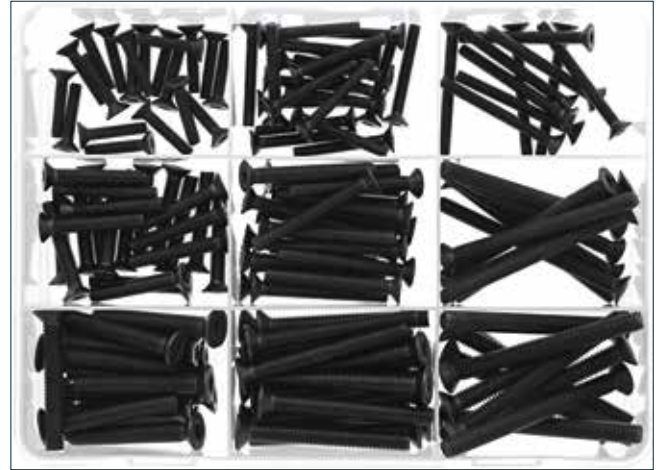

8152174131



8152174133



8152174132



8152174133CBK



815217

Sortimentskästen

Assortment boxes / Boîtes d'assortiment

Beschreibung / Description page 34/35

8152174134



8152174150



8152174135



8152174150CBK



8152174136



8152174151



815217

Sortimentskästen
 Assortment boxes / Boîtes d'assortiment
 Beschreibung / Description page 34/35

8152174151CBK



8152174154CBK

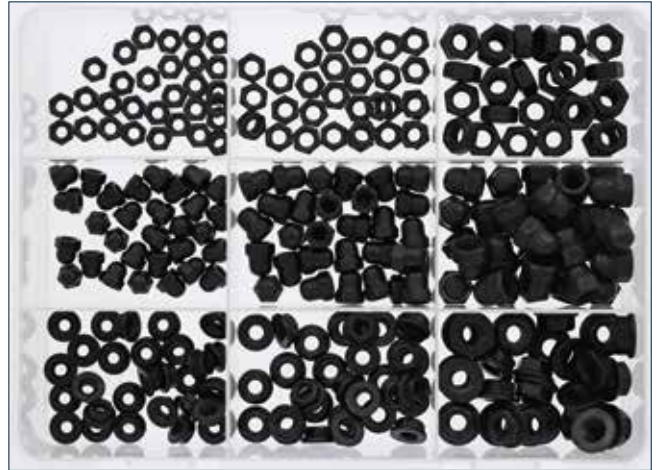

8152174152

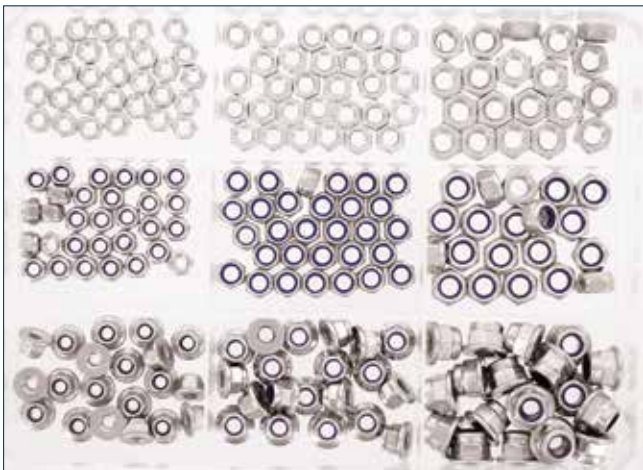

8152174155CBK



8152174153



8152174160



815217

Sortimentskästen

Assortment boxes / Boîtes d'assortiment

Beschreibung / Description page 34/35

8152174170



8152174171







Beispiel: 8152174020
Par exemple: 8152174020



Folgen Sie uns auch auf







www.marinetech.de

-  **Lernen Sie unser Unternehmen kennen: Hintergründe, News, das Team und vieles mehr ...**
-  Get to know our company: Background, news, the team and much more ...
-  Apprenez à connaître notre entreprise: les antécédents, les nouvelles, l'équipe et bien plus encore ...
-  Conozca nuestra empresa: Información de fondo, noticias, el equipo y mucho más ...
-  Poznaj naszą firmę: Informacje ogólne, wiadomości, zespół i wiele więcej ...



www.marinetech.shop

-  **Das ganze Sortiment einfach per Mausclick bestellen.**
-  Simply order the entire range for point-and-click
-  Commandez toute la gamme par un simple clic de souris.
-  Pida todo el surtido con un simple clic del ratón.
-  Zamówienie całego asortymentu po prostu przez kliknięcie myszką.







www.marinetech.de/katalog

-  **Der Marinetech-Katalog to-go: Zum digitalen Blättern und als Downloadoption mit allen aktuellen Neuheiten und Sonderangeboten.**
-  The Marinetech catalog to-go: For browsing digitally and as a download option with all the latest innovations and special offers.
-  Le catalogue Marinetech à emporter: pour la navigation numérique et comme option de téléchargement avec toutes les nouveautés et les offres spéciales du moment.
-  El catálogo de Marinetech para llevar: Para hojearlo digitalmente y como opción de descarga. con las últimas novedades y ofertas especiales.
-  Katalog Marinetech to-go: Do cyfrowego przeglądania i jako opcja do pobrania z wszystkimi najnowszymi nowościami i ofertami specjalnymi.



www.marinetech.de/downloads

-  **Unser Download-Center mit vielen weiteren Infos zum Download**
-  Our download hub with a lot more information to download
-  Notre centre de téléchargement avec beaucoup plus d'informations sur le téléchargement
-  Nuestro centro de descargas con mucha información adicional para descargar
-  Nasze centrum pobierania z wieloma dodatkowymi informacjami do pobrania



Marinotech Edelstahlhandel GmbH & Co. KG

Marschgehren 16 · 28779 Bremen
Deutschland / Germany

Tel. +49 421 - 69056 - 0
Fax +49 421 - 69056 - 50
info@marinotech.de

» www.marinotech.shop

» www.marinotech.de

Folgen Sie uns auch auf

